

High Speed Current Amplifier

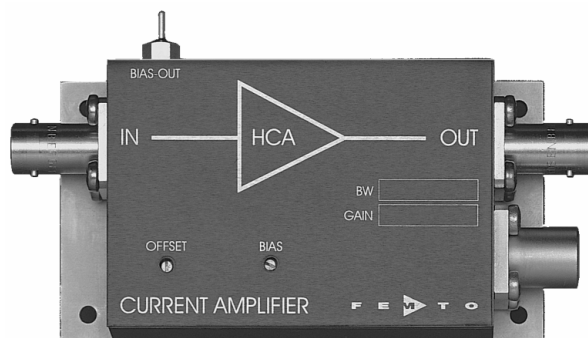

<p>Features</p>	<ul style="list-style-type: none"> • Bandwidth DC ... 400 MHz • Rise / Fall Time 1 ns • Optimized for Low Pulse Distortion – Almost No Overshoot or Ringing will Occur • Transimpedance (Gain) 5×10^3 V/A 																																																					
<p>Applications</p>	<ul style="list-style-type: none"> • Photodiode and Photomultiplier Amplifier • Spectroscopy • Ionisation Detectors • Ideal for Analyzing Digital Signals (No Baseline Shift at any Digital Code) • Preamplifier for A/D Converters, Digitizers etc. 																																																					
<p>Specifications</p>	<table border="0"> <tr> <td></td> <td><i>Test Conditions</i></td> <td>$V_s = \pm 15$ V, $T_a = 25^\circ$C</td> </tr> <tr> <td rowspan="2">Gain</td> <td>Transimpedance</td> <td>5×10^3 V/A (@ 50 Ω load)</td> </tr> <tr> <td>Gain Accuracy</td> <td>± 2 %</td> </tr> <tr> <td rowspan="5">Frequency Response</td> <td>Lower Cut-Off Frequency</td> <td>DC</td> </tr> <tr> <td>Upper Cut-Off Frequency (- 3 dB)</td> <td>400 MHz (± 10 %, @ Csource 2 to 4 pF)</td> </tr> <tr> <td></td> <td>350 MHz (± 10 %, @ Csource 5 to 10 pF)</td> </tr> <tr> <td>Max. Source Capacitance</td> <td>10 pF (incl. cable, e.g. typical coax cable 1 pF/ cm)</td> </tr> <tr> <td>Rise / Fall Time (10 % - 90 %)</td> <td>1.0 ns (@ Csource 2 to 4 pF) 1.3 ns (@ Csource 5 to 10 pF)</td> </tr> <tr> <td></td> <td>Gain Flatness</td> <td>± 0.3 dB</td> </tr> <tr> <td rowspan="10">Input</td> <td>Equ. Input Noise Current</td> <td>21 pA/\sqrtHz (@ 100 MHz)</td> </tr> <tr> <td>Equ. Input Noise Voltage</td> <td>3.5 nV/\sqrtHz (@ 100 MHz)</td> </tr> <tr> <td>Equ. Integrated Noise</td> <td>4 μA peak-peak (independent of Csource)</td> </tr> <tr> <td>Input Bias Current</td> <td>2 μA typ.</td> </tr> <tr> <td>Input Bias Current Drift</td> <td>0.07 μA / $^\circ$C</td> </tr> <tr> <td>Offset Current Compensation</td> <td>± 200 μA, adjustable by offset trimpot</td> </tr> <tr> <td>Input Current Range</td> <td>± 200 μA (for linear amplification)</td> </tr> <tr> <td>Input Offset Voltage</td> <td>< 2 mV</td> </tr> <tr> <td>DC Input Impedance</td> <td>50 Ω (virtual) // 5 pF</td> </tr> <tr> <td rowspan="3">Output</td> <td>Output Voltage Range</td> <td>± 1.0 V (@ 50 Ω load) for linear operation and low harmonic distortion</td> </tr> <tr> <td>Max. Output Voltage Range</td> <td>± 1.5 V (@ 50 Ω load)</td> </tr> <tr> <td>Output Impedance</td> <td>50 Ω (terminate with 50 Ω load for best performance)</td> </tr> <tr> <td rowspan="2">Bias Output</td> <td>Bias Output Voltage Range</td> <td>± 12 V, adjustable by bias trimpot</td> </tr> <tr> <td>Bias Output Impedance</td> <td>10 kΩ // 1 μF</td> </tr> </table>		<i>Test Conditions</i>	$V_s = \pm 15$ V, $T_a = 25^\circ$ C	Gain	Transimpedance	5×10^3 V/A (@ 50 Ω load)	Gain Accuracy	± 2 %	Frequency Response	Lower Cut-Off Frequency	DC	Upper Cut-Off Frequency (- 3 dB)	400 MHz (± 10 %, @ Csource 2 to 4 pF)		350 MHz (± 10 %, @ Csource 5 to 10 pF)	Max. Source Capacitance	10 pF (incl. cable, e.g. typical coax cable 1 pF/ cm)	Rise / Fall Time (10 % - 90 %)	1.0 ns (@ Csource 2 to 4 pF) 1.3 ns (@ Csource 5 to 10 pF)		Gain Flatness	± 0.3 dB	Input	Equ. Input Noise Current	21 pA/ \sqrt Hz (@ 100 MHz)	Equ. Input Noise Voltage	3.5 nV/ \sqrt Hz (@ 100 MHz)	Equ. Integrated Noise	4 μ A peak-peak (independent of Csource)	Input Bias Current	2 μ A typ.	Input Bias Current Drift	0.07 μ A / $^\circ$ C	Offset Current Compensation	± 200 μ A, adjustable by offset trimpot	Input Current Range	± 200 μ A (for linear amplification)	Input Offset Voltage	< 2 mV	DC Input Impedance	50 Ω (virtual) // 5 pF	Output	Output Voltage Range	± 1.0 V (@ 50 Ω load) for linear operation and low harmonic distortion	Max. Output Voltage Range	± 1.5 V (@ 50 Ω load)	Output Impedance	50 Ω (terminate with 50 Ω load for best performance)	Bias Output	Bias Output Voltage Range	± 12 V, adjustable by bias trimpot	Bias Output Impedance	10 k Ω // 1 μ F
	<i>Test Conditions</i>	$V_s = \pm 15$ V, $T_a = 25^\circ$ C																																																				
Gain	Transimpedance	5×10^3 V/A (@ 50 Ω load)																																																				
	Gain Accuracy	± 2 %																																																				
Frequency Response	Lower Cut-Off Frequency	DC																																																				
	Upper Cut-Off Frequency (- 3 dB)	400 MHz (± 10 %, @ Csource 2 to 4 pF)																																																				
		350 MHz (± 10 %, @ Csource 5 to 10 pF)																																																				
	Max. Source Capacitance	10 pF (incl. cable, e.g. typical coax cable 1 pF/ cm)																																																				
	Rise / Fall Time (10 % - 90 %)	1.0 ns (@ Csource 2 to 4 pF) 1.3 ns (@ Csource 5 to 10 pF)																																																				
	Gain Flatness	± 0.3 dB																																																				
Input	Equ. Input Noise Current	21 pA/ \sqrt Hz (@ 100 MHz)																																																				
	Equ. Input Noise Voltage	3.5 nV/ \sqrt Hz (@ 100 MHz)																																																				
	Equ. Integrated Noise	4 μ A peak-peak (independent of Csource)																																																				
	Input Bias Current	2 μ A typ.																																																				
	Input Bias Current Drift	0.07 μ A / $^\circ$ C																																																				
	Offset Current Compensation	± 200 μ A, adjustable by offset trimpot																																																				
	Input Current Range	± 200 μ A (for linear amplification)																																																				
	Input Offset Voltage	< 2 mV																																																				
	DC Input Impedance	50 Ω (virtual) // 5 pF																																																				
	Output	Output Voltage Range	± 1.0 V (@ 50 Ω load) for linear operation and low harmonic distortion																																																			
Max. Output Voltage Range		± 1.5 V (@ 50 Ω load)																																																				
Output Impedance		50 Ω (terminate with 50 Ω load for best performance)																																																				
Bias Output	Bias Output Voltage Range	± 12 V, adjustable by bias trimpot																																																				
	Bias Output Impedance	10 k Ω // 1 μ F																																																				

High Speed Current Amplifier

Specifications (continued)	<table border="0"> <tr> <td>Power Supply</td> <td>Supply Voltage</td> <td>$\pm 15\text{ V}$</td> </tr> <tr> <td></td> <td>Supply Current</td> <td>$\pm 60\text{ mA typ.}$ (depends on operating conditions, recommended power supply capability minimum $\pm 150\text{ mA}$)</td> </tr> <tr> <td>Case</td> <td>Weight</td> <td>210 g (0.5 lbs)</td> </tr> <tr> <td></td> <td>Material</td> <td>AlMg4.5Mn, nickel-plated</td> </tr> <tr> <td>Temperature Range</td> <td>Storage Temperature</td> <td>$-40 \dots +100\text{ }^\circ\text{C}$</td> </tr> <tr> <td></td> <td>Operating Temperature</td> <td>$0 \dots +60\text{ }^\circ\text{C}$</td> </tr> </table>	Power Supply	Supply Voltage	$\pm 15\text{ V}$		Supply Current	$\pm 60\text{ mA typ.}$ (depends on operating conditions, recommended power supply capability minimum $\pm 150\text{ mA}$)	Case	Weight	210 g (0.5 lbs)		Material	AlMg4.5Mn, nickel-plated	Temperature Range	Storage Temperature	$-40 \dots +100\text{ }^\circ\text{C}$		Operating Temperature	$0 \dots +60\text{ }^\circ\text{C}$
Power Supply	Supply Voltage	$\pm 15\text{ V}$																	
	Supply Current	$\pm 60\text{ mA typ.}$ (depends on operating conditions, recommended power supply capability minimum $\pm 150\text{ mA}$)																	
Case	Weight	210 g (0.5 lbs)																	
	Material	AlMg4.5Mn, nickel-plated																	
Temperature Range	Storage Temperature	$-40 \dots +100\text{ }^\circ\text{C}$																	
	Operating Temperature	$0 \dots +60\text{ }^\circ\text{C}$																	

Absolute Maximum Ratings	<table border="0"> <tr> <td>Input Voltage</td> <td>$\pm 5\text{ V}$</td> </tr> <tr> <td>Power Supply Voltage</td> <td>$\pm 22\text{ V}$</td> </tr> </table>	Input Voltage	$\pm 5\text{ V}$	Power Supply Voltage	$\pm 22\text{ V}$
Input Voltage	$\pm 5\text{ V}$				
Power Supply Voltage	$\pm 22\text{ V}$				

Connectors	<table border="0"> <tr> <td>Input</td> <td>BNC</td> </tr> <tr> <td>Output</td> <td>BNC</td> </tr> <tr> <td>Power Supply</td> <td>LEMO series 1S, 3-pin fixed socket</td> </tr> <tr> <td></td> <td>Pin 1: +15V</td> </tr> <tr> <td></td> <td>Pin 2: -15V</td> </tr> <tr> <td></td> <td>Pin 3: GND</td> </tr> </table>	Input	BNC	Output	BNC	Power Supply	LEMO series 1S, 3-pin fixed socket		Pin 1: +15V		Pin 2: -15V		Pin 3: GND
Input	BNC												
Output	BNC												
Power Supply	LEMO series 1S, 3-pin fixed socket												
	Pin 1: +15V												
	Pin 2: -15V												
	Pin 3: GND												

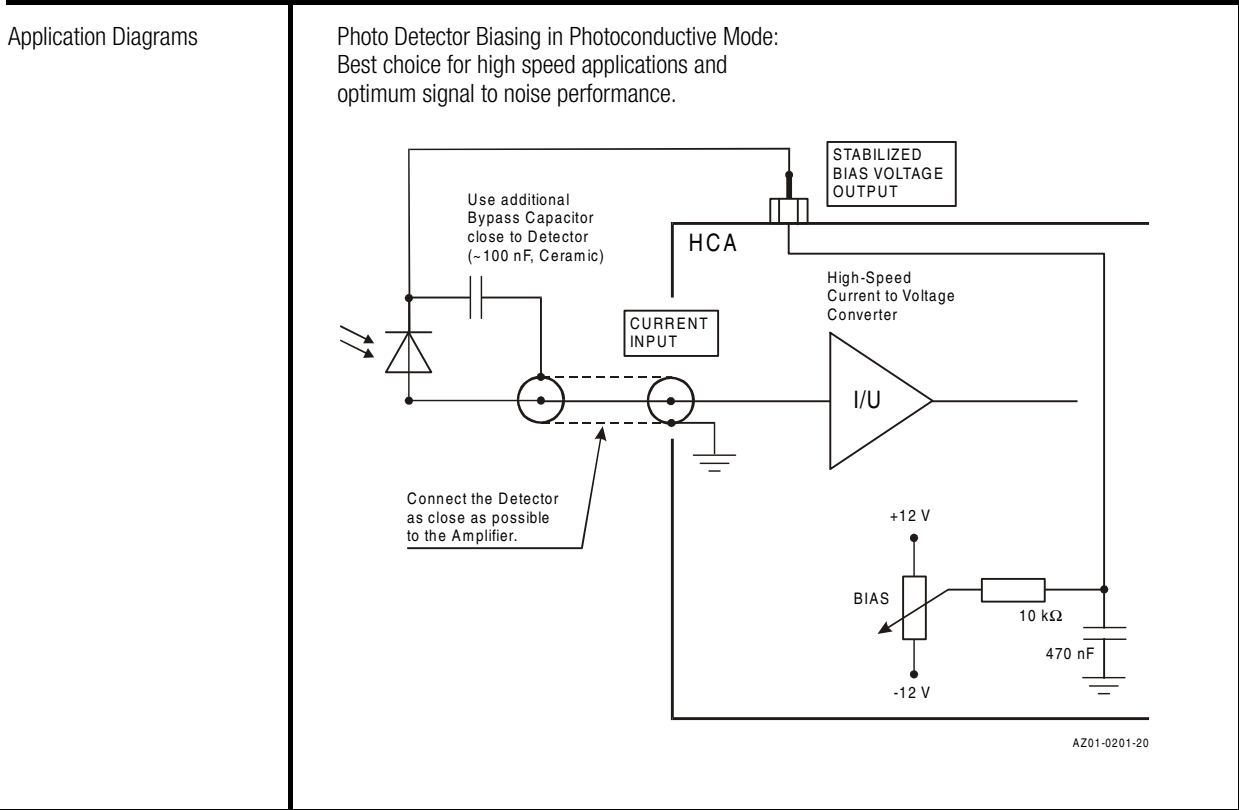
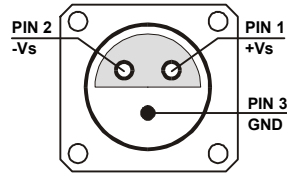

High Speed Current Amplifier

Typical Performance Characteristics

Frequency Response

Offs 16.0 dB RBW 3 MHz
 Att 0 dB * VBW 10 kHz M1[1] -2.94 dB
 Ref -4.0 dBm SWT 130ms 410.000000000 MHz

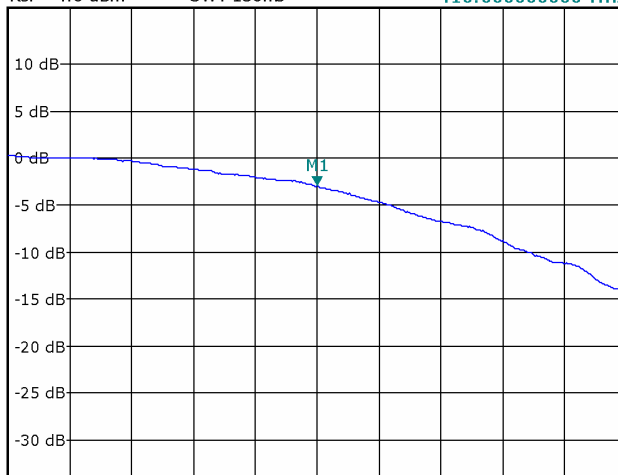

Start 20.0 MHz Stop 800.0 MHz

Noise Spectrum

Att 0 dB RBW 3 MHz
 Ref 22.4 mV * VBW 3 kHz Noise2 219.730591 nV/√Hz
 580.000000000 MHz
 Noise1 102.946035 nV/√Hz
 100.000000000 MHz

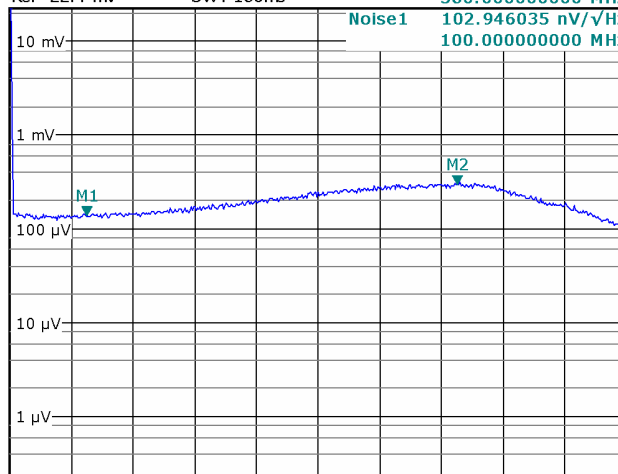

Start 0.0 Hz Stop 800.0 MHz

Note: Spectral noise data is measured at the amplifier output with open but shielded input. To determine the spectral input noise divide the measured output noise by the amplifier gain of 5×10^3 V/A, i.e.:

Marker	Frequency	Output Noise	Resulting Input Noise
1	100 MHz	103 nV/√Hz	21 pA√Hz
2	580 MHz	220 nV/√Hz	44 pA√Hz

High Speed Current Amplifier

Typical Performance Characteristics (continued)

Pulse Response to Square Wave Input Signal (with 16 times averaging)

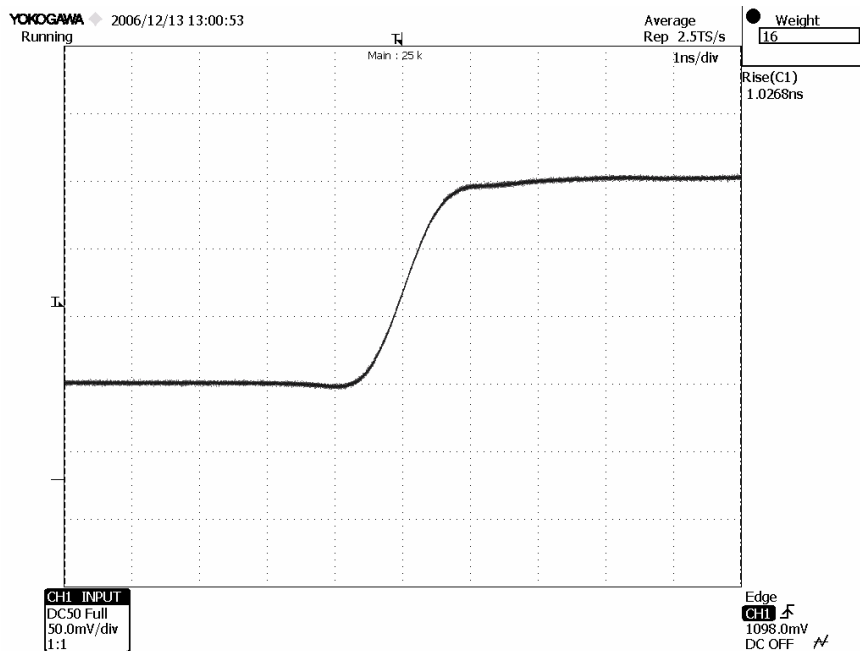

Large Signal Response
output signal for 100 MHz, 200 μ A peak-peak input signal (with 4 times averaging)

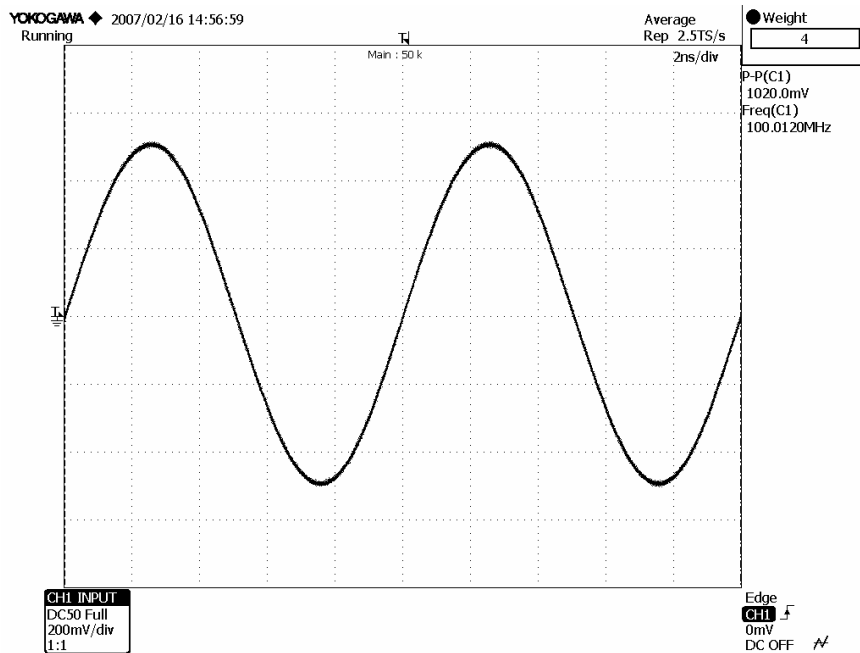

High Speed Current Amplifier

Typical Performance Characteristics (continued)

Small Signal Response
output signal for 1 MHz, 2.4 μ A peak-peak square wave input signal
(without (top) and with 64 times averaging (bottom))

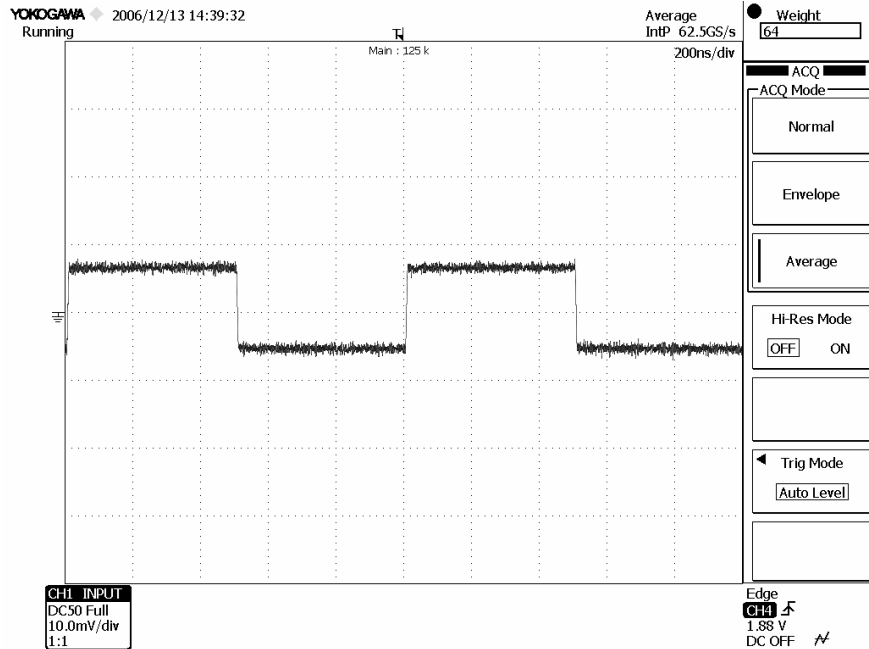
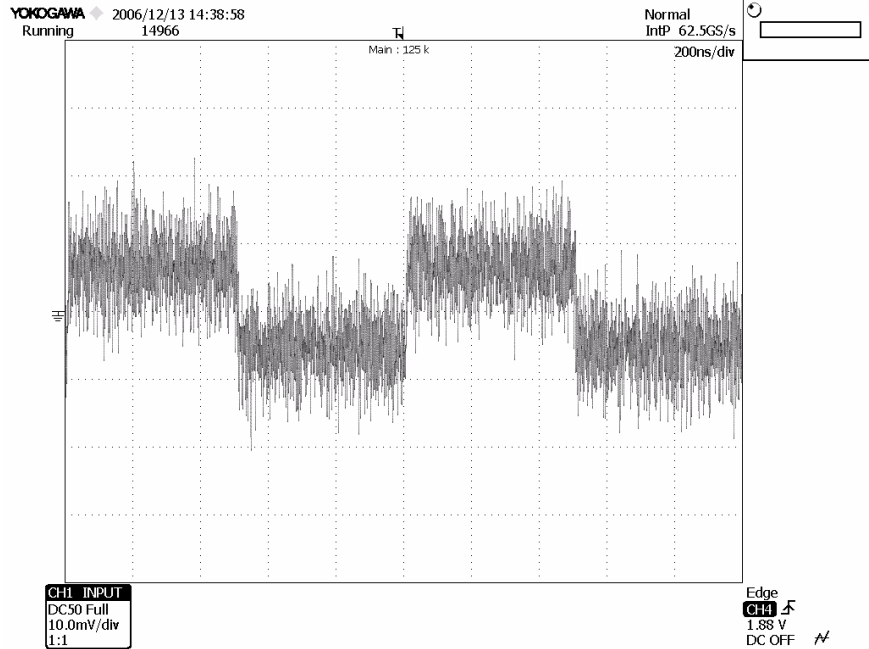

High Speed Current Amplifier

Dimensions

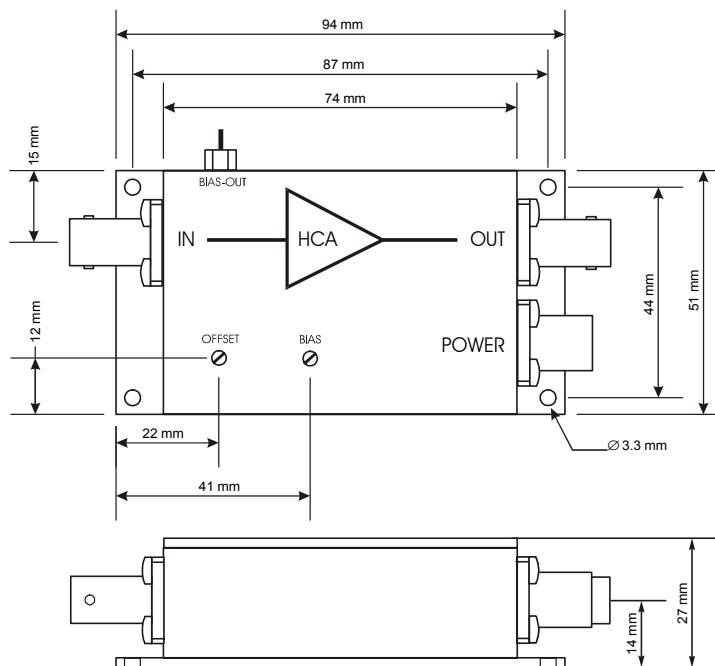

DZ01-0201-22

FEMTO Messtechnik GmbH
 Klosterstr. 64
 D-10179 Berlin · Germany
 Tel.: +49-(0)30-280 4711-0
 Fax: +49-(0)30-280 4711-11
 e-mail: info@femto.de
 http://www.femto.de

Specifications are subject to change without notice. Information furnished herein is believed to be accurate and reliable. However, no responsibility is assumed by FEMTO Messtechnik GmbH for its use, nor for any infringement of patents or other rights granted by implication or otherwise under any patent rights of FEMTO Messtechnik GmbH. Product names mentioned may also be trademarks used here for identification purposes only.
 © by FEMTO Messtechnik GmbH
 Printed in Germany